

V-100 product information



Variable area flowmeters for gases and liquids

Wide-ranging and modular: Variable area flowmeters V-100

Highly modular and adaptable for almost any requirement: Variable area flow meter with a wide range of options.

Measuring tubes in 3 sizes

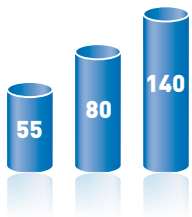

The flow meters are available with three different glass tube lengths

Measuring tube scales

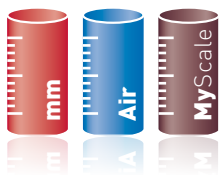

In addition to mm scales with flow rate table, glass tubes with direct reading or custom scales are available

Precise control valves

The devices are equipped with precise, hysteresis-free 15-way control valves. The valves are tightly closing

Different device setups



In addition to standard rear ports, devices with lateral and vertical ports are available

Aluminium or stainless steel



The bodies are available in aluminium or stainless steel. Sealing materials FKM or EPDM

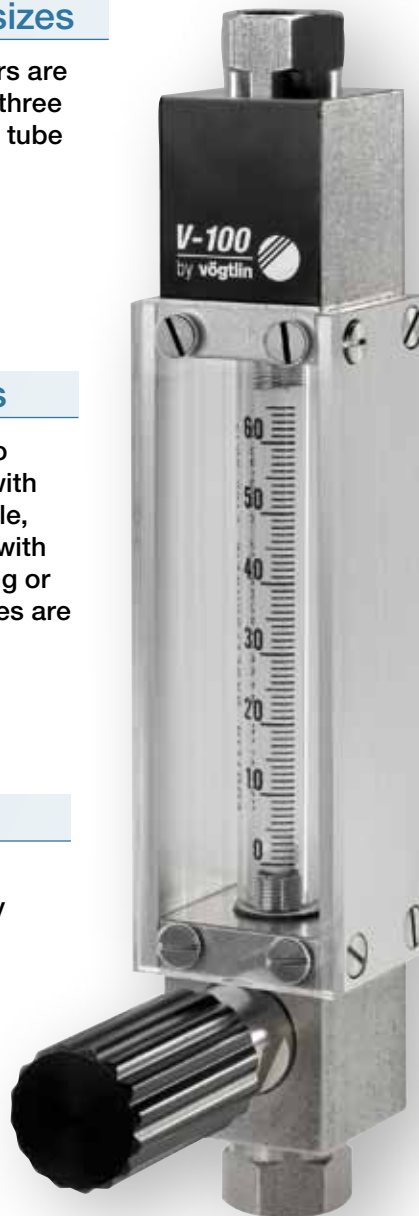

Various instruments options



We offer a range of options for the flow meters:

- Laboratory base
- Limit contact (inductive)
- Adaptation to customized gas line routing

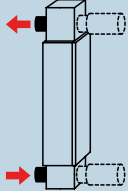

Variable area flowmeters V-100 140 with laboratory base

Technical specifications variable area flowmeters V-100

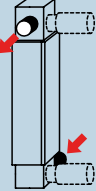
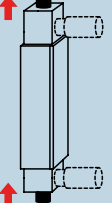
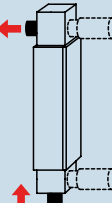
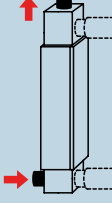
Features	Construction	Short mounting length, 3 instrument sizes		
	Connections	Rear, lateral or axial		
	Scale	Millimetric scale, direct reading scale and customer-specific scale. The scales are highly wear-resistant		
	Float type	Spherical		
	Valve	Precisely adjustable, 15-turn micro valve, practically hysteresis-free The control range (Kv-value) is optimized for the full scale		
	Body material	Aluminium or stainless steel		
	Seals material	FKM, EPDM or FFKM		
	Customization	We provide customer-specific versions		
Instrument versions	Setup	Type S* (Standard setup) Setup L, R, A, T and O (see below)		
	Material	Anodized aluminium/Nickelized brass (valve)/FKM Stainless steel/FKM Stainless steel/EPDM Stainless steel /FFKM		
	Connection	G 1/4" female* G 1/8" female G 1/4" female for compression fittings NPT 1/4" female		
	Valve at inlet* or outlet	With standard knob* Without valve		
Technical data	Type	V-100 55	V-100 80	V-100 140
	Turndown ratio	10:1	10:1	10:1
	Accuracy in % of full scale	±5%	±4%	±2%
	Measuring tube length	55 mm	80 mm	140 mm
	Scale length	40 mm	65 mm	120 mm
	Float	spherical	spherical	spherical
	Max. pressure	20 bar	20 bar	16 bar
	Max. temperature	100 °C	100 °C	100 °C
Max. pressure drop	20 mbar	20 mbar	30 mbar	
Options	Calibration report (factory certificate)			
	Additional flow rate table for mm-scale			
	Laboratory base			
	Back cover (milky plexiglass)			
	Limit switch: min. limit switch, max. limit switch			
	Relays 24 Vdc for limit switch, relays 230 Vac for limit switch			
	Hose connectors PVC			
	Customized measuring tube scale			
Setup	Setup S (standard)	Setup L	Setup R	
				
	Setup A (stainless-steel only)	Setup T (stainless-steel only)	Setup O (stainless-steel only)	
				

*Standard – Subject to technical alterations

Measuring ranges variable area flowmeters V-100

The measuring tubes are available with three different scales:

1. Measuring range for direct reading scales – Standard scales						
Medium	Air					
Reference conditions	l/h / 1.21 bara / 20 °C			mln/min / 1.013 bara / 20 °C		
	V-100 55	V-100 80	V-100 140	V-100 55	V-100 80	V-100 140
	0.12 – 1.2	0.12 – 1.2	–	–	10 – 120	10 – 100
	0.2 – 2	0.2 – 2	0.2 – 2	–	20 – 240	40 – 220
	0.3 – 3	0.3 – 3	0.3 – 3	–	60 – 640	50 – 540
	0.5 – 5	0.5 – 5	0.5 – 5	l/min / 1.013 bara / 20 °C		
	0.8 – 8	0.8 – 8	0.8 – 8	V-100 55	V-100 80	V-100 140
	1.6 – 16	1.6 – 16	1.6 – 16	–	0.1 – 1	0.1 – 1
	4 – 40	4 – 40	4 – 40	–	0.3 – 2.2	0.2 – 2.2
	6 – 60	6 – 60	6 – 60	–	0.5 – 5	0.5 – 6.0
	10 – 100	10 – 100	10 – 100	–	0.2 – 10	1.5 – 10.5
	25 – 250	25 – 250	25 – 250	–	2 – 20	2 – 26
	50 – 500	50 – 500	50 – 500	–	4 – 32	6 – 51
	80 – 800	80 – 800	80 – 800	–	–	–
	120 – 1200	120 – 1200	120 – 1200	–	–	–
	140 – 1400	–	140 – 1400	–	–	–
	–	–	200 – 2000	–	–	–
Medium	Water					
Reference conditions	l/h / 20 °C					
	V-100 55	V-100 80	V-100 140	V-100 55	V-100 80	V-100 140
	0.25 – 2.5	–	–	–	–	0.25 – 2.5
	0.5 – 5	–	–	–	–	0.5 – 5
	1.2 – 12	–	–	–	–	1.2 – 12
	2.5 – 25	–	–	–	–	2.5 – 25
	4 – 40	–	–	–	–	4 – 40
	6 – 60	–	–	–	–	6 – 60
	7 – 70	–	–	–	–	7 – 70

2. Measuring range for mm scales (with flow table) – For varying operating conditions (temperature, pressure, medium)				
Medium	Air		Water	
Reference conditions	l/h / 1.21 bara / 20 °C		l/h / 20 °C	
Measuring range	smallest	highest	smallest	highest
V-100 80	0.04 – 1.75	100 – 5000	0.0005 – 0.015	10 – 100
V-100 140	0.15 – 2.25	500 – 5000	0.001 – 0.018	12 – 150

- ### 3. Customer-specific scales
- For customer-specific scales please provide the following specifications:
- Medium, mixture if applicable and max. flow
 - Pressure in bar, absolute (only required for gases)
 - Medium temperature, if applicable medium viscosity and density

Dimensions variable area flowmeters V-100

Type	Dimensions in mm		
	A	B	C
V-100 55	102.5	89.5	61.5
V-100 80	145.5	114.5	86.5
V-100 140	205.5	174.5	146.5
Fittings		D	Thread depth
G1/4" female		12	7
G1/8" female		12	8
G1/4" female for compression fittings		17	12
NPT 1/4"		16	9
Blind nipple (setup L & R only)		5.5	–

Find detailed dimensions in the V-Flow Line manual

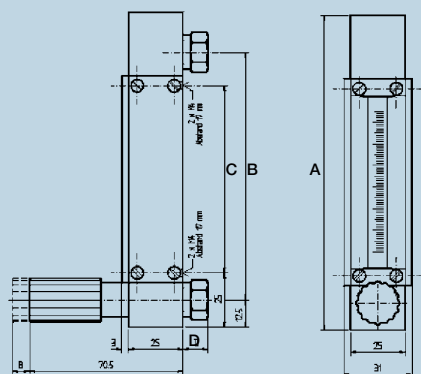

Type code variable area flowmeters V-100

Instrument type	V-100	F	L	V																	
Instrument size	55									A											
	80									B											
	140									C											
Materials (body, seals)	Aluminium/brass, FKM									S											
	Stainless steel, FKM									E											
	Stainless steel, EPDM									T											
	Stainless steel, FFKM									W											
	Customer-specific / OEM									K											
Setup	Setup S**									S											
	Setup L									L											
	Setup R									R											
	Setup A (stainless steel only)									A											
	Setup T (stainless steel only)									T											
	Setup O (stainless steel only)									O											
	Customer-specific / OEM									K											
Valve (position)	Valve at the inlet**									S											
	Valve at the outlet									A											
	Without valve									O											
	Customer-specific / OEM									K											
Process connection (in- and outlet)	G 1/4" female**																		S		
	G 1/8" female																		B		
	G 1/4" female (for compression fittings)																		C		
	NPT 1/4" female																		D		
	Customer-specific / OEM																		K		
Measuring tube scale	Millimetric scale																			M	
	Direct reading scale																			D	
	Customer-specific / OEM																			K	
Options	Additional flow rate table for mm-scale																				T
	Calibration report																				P
	Laboratory base																				F
	Back cover, plexiglass, milky																				R
	Min. limit switch																				G
	Max. limit switch																				I
	Relays 24 Vdc for limit switch																				J
	Relays 230 Vac for limit switch																				H
	Hose connectors PVC, G 1/4" / 4mm																				N
	Hose connectors PVC, G 1/4" / 6mm																				O
	Hose connectors PVC, G 1/4" / 8mm																				Q
	Customized measuring tube scale																				M
	Customer-specific / OEM																				K
Type code		F	L	V	-																

** Standard

Please contact our sales for all questions concerning configuration settings and customized versions: **+41 61 756 63 00** or **sales@voegtlin.com**

Do you have any questions about our products?

Give us a call:

+41 (0)61 756 63 00

Or write us an e-mail:

info@voegtlin.com

You will find your local Vögtlin sales partner on the internet:

www.voegtlin.com

Vögtlin Instruments AG – flow technology

Langenhagstrasse 1 | 4147 Aesch (Switzerland)

Phone +41 (0)61 756 63 00 | Fax +41 (0)61 756 63 01

www.voegtlin.com | info@voegtlin.com

vögtlin 
instruments